



Connex-02

Installation Guide

Product Part Number: AC-AMD00-110-F-C0-000

Literature Ref: AC-AMD00-850ML

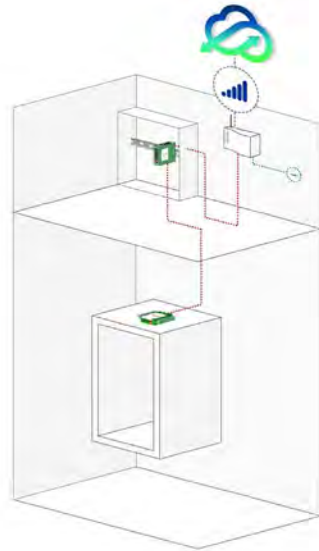

Typical DCP System Architecture for Connex-02

PRODUCT DESCRIPTION

The Connex-02 is a MK-CANBus enabled I/O module that, in conjunction with a Digital Communication Platform (DCP), provides remote lift monitoring through the Avire Hub online platform.

The Connex-02 has inputs and outputs that are fully configurable through the Avire Hub. Each input has different monitoring modes to choose from, including if the lift is in or out of service, showing when the lift is in maintenance mode, logging engineer arrival and departure and monitoring of the door open and close cycles.

In addition, the Connex-02 allows a fully configurable Event Monitoring mode where the user can connect any device and enter the name of the event on the Avire Hub which will be visible in the events log.

ITEMS REQUIRED FOR INSTALLATION

In the Box

- + Connex-02
- + DIN rail
- + P5 BL2 connector (x7)
- + P5 BL4 connector (x2)
- + DCP connector (x1)

Not Included

- + Wiring cables
- + Screwdriver
- + Technician on Site button
- + CANBus Splitter (used for multiple lift shafts, please check with Avire sales)
- + DCP (Digital Communication Platform)*

* Without installation of a DCP the Connex-02 will be unable to transfer data out of the lift shaft

Quick Summary

- + Elevator Safety
- + Installation
- + Wiring diagram
- + Single Connex-02 Installation
- + Input & Output
- + Switch Configuration
- + LED Indicator
- + Adding Connex-02 to the Avire Hub
- + Removing Connex-02 from a DIN rail

1. Elevator Safety

Follow all Health & Safety rules and all necessary precautions before taking the lift out of service.

2. Installation

Depending on selected application, locate required lift signals and use existing DIN rail or mount a standard in the location where Connex-02 will be installed, this is either:

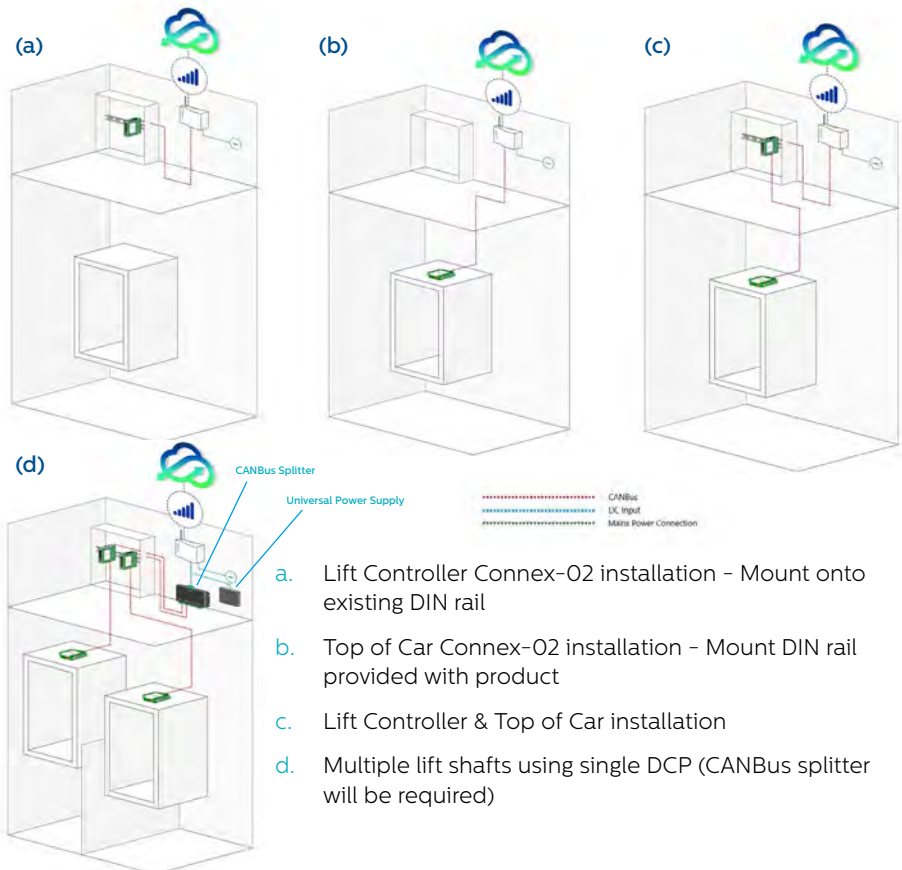

3. Wiring diagram

Wire the device using the wiring diagram shown below.

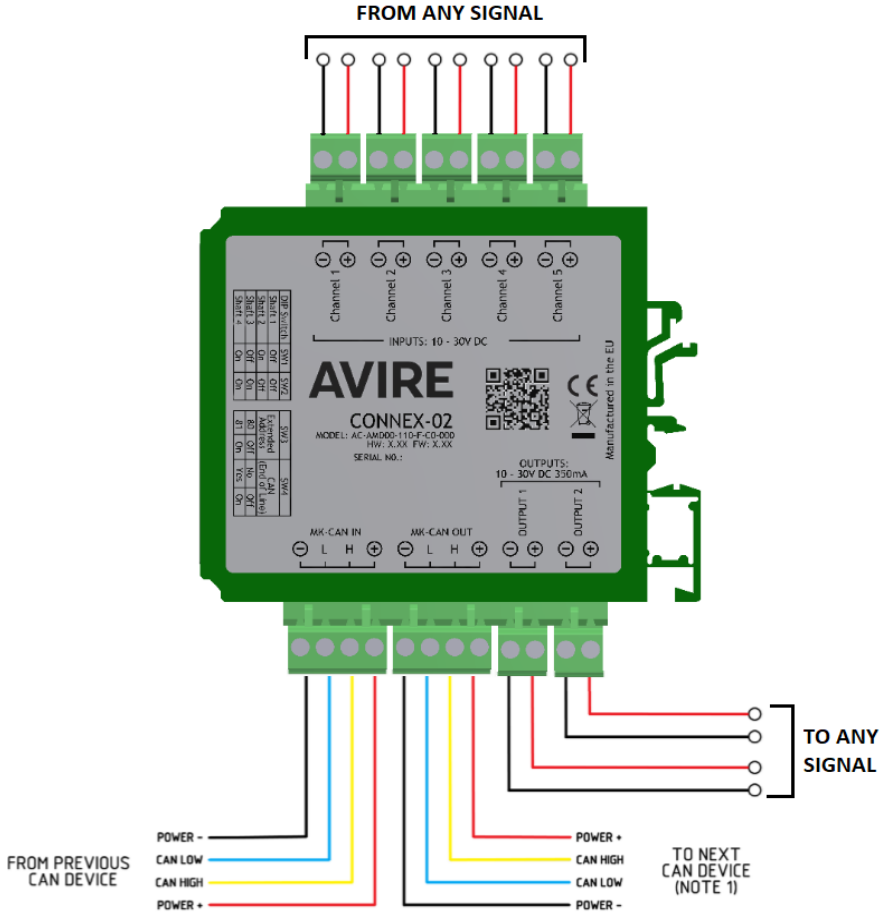

(see section 5, Switch Configuration when using more then one device)

4. Single Connex-02 Installation

4.1 Before installation find required lift signals (e.g. Out of Service, Lift Maintenance)

4.2 Install Connex-02 in close proximity to the lift signals for ease of wiring and use DIN rail provided in kit or existing for fixing. See section 10 for removal instructions if required.

4.3 Connect the 4 wire J8 'CAN' DCP to the Connex-02 CAN 'IN' for HUB communication.

4.4 Once DCP 'CAN' connection is made to the Connex-02 MK CAN IN, wire the lift signals as required to the input/output (see Section 5 'Input & Output for further details).

Additional steps for multiple Connex-02 installation...

4.5 Depending on the location of the lift signals required, two Connex-02 can be used via CAN IN and CAN OUT this links one device to another (see section 2 installation figure C)

4.6 Using more than one device on a 'CAN' line will require EOL (End Of Line) to be configured (see section 6 Switch Configuration 6.3)

5. Inputs & Outputs

5.1 Inputs

There are 5 opto-isolated inputs available on Connex-02 which must be driven from an external 10 – 30VDC supply with a switching voltage between 4 and 8 volts. The input voltage is rated 12VDC at 3mA max or 30VDC at 7mA max; inputs can be configured as normally OPEN or normally CLOSED using the Avire Hub.

Configuration of inputs & outputs must be made using the Avire Hub.

5.1.1 Input from External Sources – Any lift signal

Each of the 5 inputs within Connex-02 is designed to accept any type of signal from any external source such as Out of Service, Lift in Maintenance, Doors open/close or any other signal. The installer must identify a suitable signal at the specified rating before wiring. The functionality of each input can be defined using the Avire Hub which is explained in section 9.

5.1.2 Technician on Site – Measure service engineer arrival and departure

The “Technician on Site” push button is available separately and is pre-wired for plug and play which can be used in any of the 5 inputs.

Product Part Number	Product Description
MC-ART01-200-0-00-000	“Technician on Site” push button

Configure an automatic time out on the Avire Hub so the technician on site input is automatically disabled after a pre-determined amount of time (please refer to section 9.2.1.2 “Technician on Site set up” for more information)

It is also possible to reset this input remotely on the Avire Hub (please refer to section 9.2.1.2 “Technician on Site set up” for more information)

To change connectors or confirm wiring, please consult the table below:

Corresponding Number	Wiring colour
1	Brown
2	Green
3	White
4	Yellow

TO ANY N/O or N/C SIGNAL

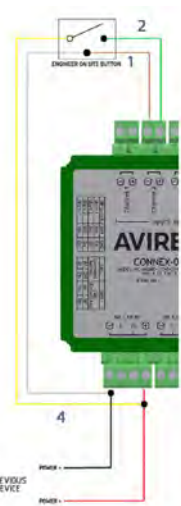

5.2 Outputs

There are 2 opto-isolated outputs. The relays can switch a maximum resistive load of 30VDC at 350mA. The voltage drop across the relay is less than 1V when the load is on. Outputs can be configured as normally OPEN or normally CLOSED using the Avire Hub (see section 9.3 for more details).

6. LED Indicator

LEDs on the side of Connex-02 show the status of each input, the outputs and other functions. If any input is connected to a input and Connex-02 receives signal the LED's light will be on. The LED indicator light will be ON when there is a voltage applied to the corresponding input/output.

LED	Label	Function	Active
1	CH1	Input 01	ON
2	CH2	Input 02	ON
3	CH3	Input 03	ON
4	CH4	Input 04	ON
5	CH5	Input 05	ON
6	OP1	Output 01	ON
7	OP2	Output 02	ON
8	TOS	Technician on site*	ON
9	RX	CAN data RX	
10	TX	CAN data TX	
11	OK	Heartbeat flashes every 1 second when device is on	Flash every 1 second

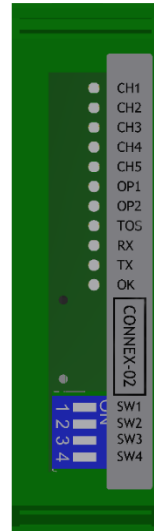

*The corresponding input LED 2 shows when the button is pressed and LED 8 shows the whether the "Technician on site" mode is activated.

6. Switch Configuration Cases

Connex-02 comes preset as an end of line device (switch “4” configured as “on”) as per figure 1 below.

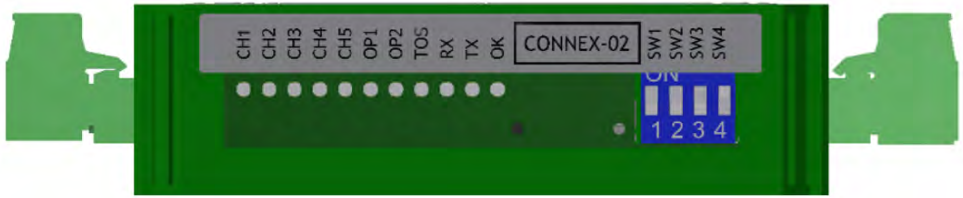
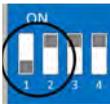

Fig1*

6.1 In a system with more than one lift car select the lift shaft for each Connex-02, using configuration switch “1” and “2”. The below table shows how to set the ID for each Connex-02.

Default



Lift ID	Lift 1	Lift 2	Lift 3	Lift 4
SW1	OFF <input type="checkbox"/>	<input type="checkbox"/> ON	OFF <input type="checkbox"/>	<input type="checkbox"/> ON
SW2	OFF <input type="checkbox"/>	OFF <input type="checkbox"/>	<input type="checkbox"/> ON	<input type="checkbox"/> ON

Fig 2**

6.2 Up to two devices can be installed per simplex lift installation. Select second Connex-02 as 81 using switch “3”.

Default

Device #	SW3
80	OFF <input type="checkbox"/>
81	<input type="checkbox"/> ON

6.3 If Connex-02 is the End of Line (EoL) device, assign the device as EoL by switching configuration switch “4” to ON. Otherwise, configuration switch “4” should be OFF.

Default

EoL device	SW4
No	OFF <input type="checkbox"/>
Yes	<input type="checkbox"/> ON

*e.g. fig. 1 is set to Lift 1, the device is installed in the Landing/Motor Room control cabinet and is the End of Line device.

**e.g. fig 2 is set to Lift 3, with the device installed at the top of car and is the End of Line device.

8. Avire Hub

Please contact your local sales office for access to the Avire Hub.

The link to the Avire Hub is <https://avirehub.avire-global.com>

To view installation tutorial videos please go to the “Help” section of the Avire Hub.

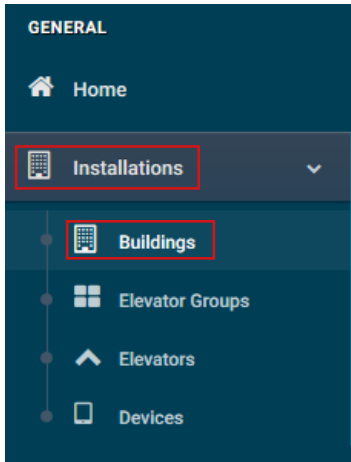

Click on “Installations” in the menu on the side and then on “Buildings”. Inside of “Buildings” tab click on “Create Building”

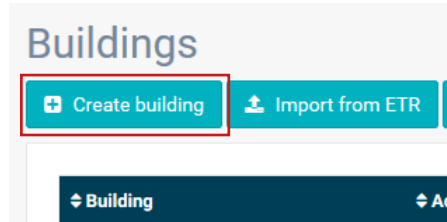

Enter information relevant to your installation in General data

General data

Building *	<input type="text"/>
Address *	<input type="text"/>
City	<input type="text"/>
Province	<input type="text"/>
Latitude	<input type="text"/>
Longitude	<input type="text"/>
Postcode	<input type="text"/>
Country	Select <input type="text"/>
Comments	<input type="text"/>
Tags	add a tag <input type="text"/>
Group	ABC Ascenseurs <input type="text"/>

On the other side of the page please enter the number of elevator group you have in this installation and how many elevators you have in the group. As an example, if this is a simplex installation the number of elevator groups will be “1” and the number of elevators will also be “1”. If it’s a duplex installation it will be “1” and “2” respectively.

Form

The screenshot shows a configuration form with the following elements:

- A field labeled "Number of elevator groups" with a dropdown menu showing the value "1".
- A field labeled "Number of elevators per elevator group" with a dropdown menu showing the value "1".
- A field labeled "Change name of elevators group" with a text input containing "Group 1".
- A field labeled "Select number of elevators" with a dropdown menu showing the value "1".
- A "Next >" button in the bottom right corner.

You can also edit the group names to easily identify installations. Once all information is entered click “Next”.

In the new page, you should be able to see Groups and Elevators. Click on “Add Gateway” under “Gateway” tab and select the relevant option to your system setup.

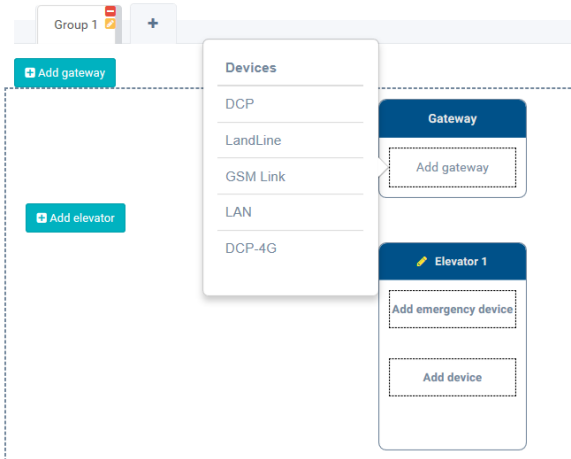

Please note, you will need to setup the Gateway before the Connex-02 can connect to the Avire Hub. Please follow device instructions for further information. Once selected click “Save” in the left corner under the General data column.

The screenshot shows a 'Group' dropdown menu with 'Administrator' selected. Below it, there are two buttons: a blue 'Save' button with a document icon and a red 'Cancel' button with an 'X' icon. The 'Save' button is highlighted with a red box.

Next you will need to add the Connex-02 to your elevator as a device. Click **'Add device'** and select the Connex-02 option.

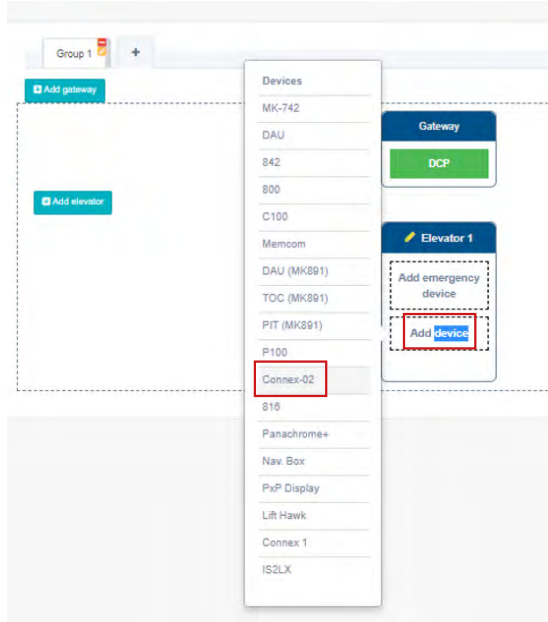

Once selected, a pop-up box will appear asking you to enter the CAN device. The CAN device (80 or 81) this is used to identify the Connex-02 within the installation. If you are installing more than one Connex-02 you must ensure they are not configured to the same CAN device. Once configured click 'Save' to store the Connex-02 in the installation.

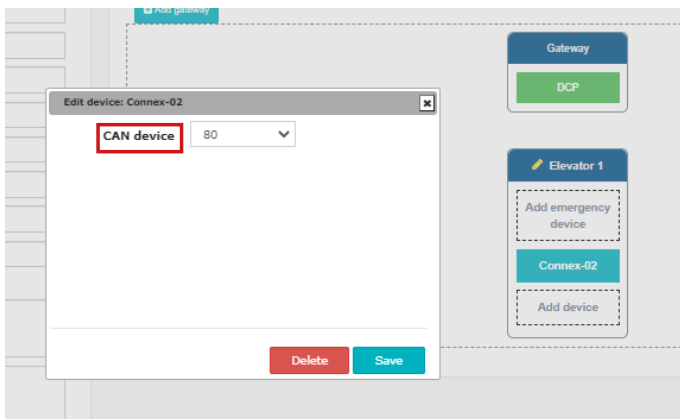

9. Configuring Connex-02 on the Avire Hub

To configure the Connex-02 you will need to be in the device setup page. You can enter the setup page by double clicking on the Connex-02 icon in the Building setup and then clicking 'Access' which will bring up the parameter setup page for that device.

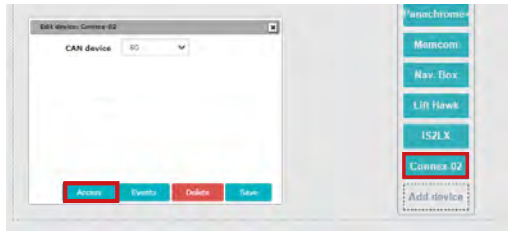

9.1 Parameters Group

The Parameters Group shows the list of the inputs and outputs that can be configured. Additionally, the user can see the System information and the option to select the "Engineering Off Site" view as well.

Each item on the Parameter Group will show a different view under the "Parameters" field. All 5 inputs have a similar view and the same number of Parameters, this also applies to the 2 outputs.

The installer can connect an input to any lift signal information such as lift in maintenance, out of service signal, doors status signal or any other lift related signal.

Bear in mind that any changes made to the Avire Hub to configure Connex-02 only apply if the **'Program'** button is pressed, otherwise any changes are not stored in the device.

Parameter groups

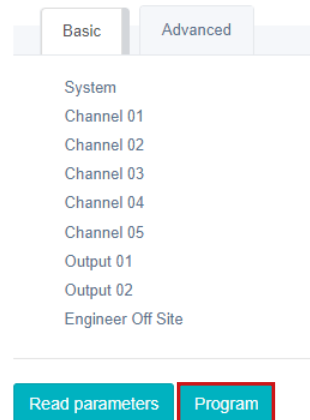

9.2 Input Configuration

All 5 inputs are identical to configure and can be configured the same way.

9.2.1 Monitoring Mode

The "Monitor Mode" allows the user to select the monitoring feature of the inputs. The drop down menu shows 5 different option which when triggered on the Connex-02, registers that as a lift status event on the Avire Hub`.

P188 - Ch05 Monitoring Mode:

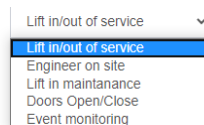

9.2.1.1 Lift in/out of Service

Reports on the “List Status Events” log either “Lift in service” or “Lift out of service” when input is toggled.

9.2.1.2 Engineer on Site

When the “Engineer/Technician on Site” button (sold separately) is pressed to inform the arrival of an Engineer, Connex-02 enters the “Engineer on site” mode and reports on the “List Status Events” log “Engineer on site (local)”. To exit the “Engineer on site” mode to inform that the Engineer is leaving the site, the button should be pressed once more where the event “Engineer off site (local)” is reported on to the “List Status Events” log.

“Engineer off site”

In case of an Engineer leaves the site without pressing the button, simply press “Set engineer as off site” button on the Avire Hub. This will report an “Engineer off site on (remote)” the “List Status Events” log and force the device to exit “Engineer on site” mode.



Additionally, it is possible to set a time-out for Connex-02 to automatically exit the “Engineer on site” mode after the “Engineer/Technician on Site” button is pressed.

The time-out should be entered in minutes and the Connex-02 will exit “Engineer on site” mode after this time has been elapsed and report to the “List Status Events” log “Engineer off site (time-out)”.

P169 - Ch05 Engineer off site - Timeout (in minutes):

180

9.2.1.3 Lift in Maintenance

Reports on the “List Status Events” log either “Lift in maintenance” or “Lift off maintenance” when the input is toggled

9.2.1.4 Doors Open/Close

Reports on the “List Status Events” log “Doors Cycles Threshold reached” when the input is toggled, in other words every time the lift doors open and close. This monitoring mode should be selected to monitor the door cycles of a lift for preventive maintenance after a set number of door cycles, hence it should be used in conjunction with the “Count Threshold” feature of an input. See section 9.3 for more details.

Furthermore, this monitoring mode allows the user to see an animated version of the doors opening and closing in the “LMS Lite” page on the Avire Hub.

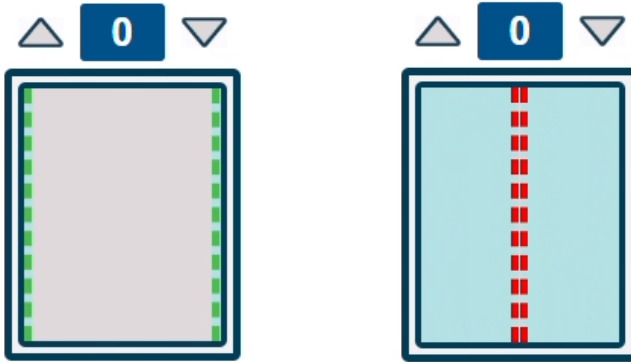

9.2.1.5 Event Monitoring (Events)

Reports on the “List Status Events” log the event name entered by the user when the input is toggled. Each input has two fields called “Event Name” and “Event Clear”, which is the exact text reported on the “List Status Events” log.

For example the Event name and Event Clear are “SensorON” and “SensorOFF” respectively.

P128 - Ch05 Event Name (Event Monitoring Mode only):

P148 - Ch05 Event Clear (Event Monitoring Mode only):

Once the input signal is toggled, the entered text “SensorON” and “SensorOFF” are reported on the “List Status Events” log.

↕ Date	↕ Building name	↕ Label
01/06/2020 13:23:15	EcoSystem Development Unit 1	SensorOFF
01/06/2020 13:23:03	EcoSystem Development Unit 1	SensorON

9.2.2 Enable / Disable

This feature allows each input to be either Enabled or Disabled. When Disabled there will be no messages reported on the “List Status Events” log even if there is a toggle on the input. Note that by default all inputs are set to Enabled.

9.2.3 Current Status

A read only function that shows the current status of the input when the “Read parameters” button is pressed.

9.2.4 Normal State

Defines whether the normal state of the input is OPEN or CLOSE. OPEN represents a potential difference between both terminals of the input, CLOSE represents a short between both terminals of the input.

9.2.5 Event Count

Every time that a toggle occurs on the input, the Event Count number is increased by 1. The increment also occurs if the input is disabled. When the “Read parameters” is pressed, the Event Count field is updated with the count number. The user can also use this field to write any number, which means the count can be reset by entering the value 0.

9.2.6 Count Threshold

The Count Threshold is the required number of toggles (Event Count) on the input before a message is reported on the “List Status Events” log. For example if the Count Threshold of input 03 is 1000, the Connex-02 will only report a message on the “List Status Events” log once the value of “Event Count” reaches 1000.

9.3 Outputs

The 2 outputs are identical and can be configured the same way.

Parameters

P137 - Output 01 Name:

P180 - Output 01 Mode:

Output with Hold Time ▾

P150 - Output 01 Normal State:

OPEN ▾

P149 - Output 01 Status:

CLOSE ▾

P130 - Activate/Deactivate

Toggle

P152 - Output 01 Hold Time (seconds):

10

9.3.1 Output Name

The output name field is a way for the user to enter a name for the output. The output name will show as an event on the Avire Hub when triggered.

9.3.2 Output Mode

The output Mode allows the user to choose mode of which the output will operate. There are 2 modes to choose from.

P180 - Output 01 Mode:

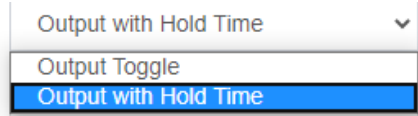

9.3.2.1 Output with Hold Time

The output can be driven for a period of time with a click of a button. The “Output with Hold time” mode allows the user to drive the output for the time (in seconds) entered in the “Output Hold Time” field. Once the Hold Time has been programmed to Connex-02 and the “Toggle” button pressed, the output will be ON for the period of the Hold Time only.

9.3.2.2 Output Normal State

Defines whether the normal state of the output is OPEN or CLOSE. OPEN represents a potential difference between both terminals of the output, CLOSE represents a short between both terminals of the output.

9.3.3 Output Normal State

Defines whether the normal state of the output is OPEN or CLOSE. OPEN represents a potential difference between both terminals of the output, CLOSE represents a short between both terminals of the output.

9.3.4 Output Status

A read only function that shows the current status of the output when the “Read parameters” button is pressed. This is either OPEN or CLOSE.

9.3.5 Activate / Deactivate

This is the “Toggle” button that drives the output. The output will change state when this button is clicked from OPEN to CLOSE or vice versa.

P130 - Activate/Deactivate

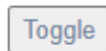

9.3.6 Output Hold Time

This field is used to add the time (in seconds) that the output is driven for when the “Toggle” button is pressed whilst in “Output with Hold Time” mode.

10. Removing Connex-02 from a DIN rail

When removing Connex-02 from a DIN rail the connectors must be removed so a screwdriver can be used to lever the clips from the rail.

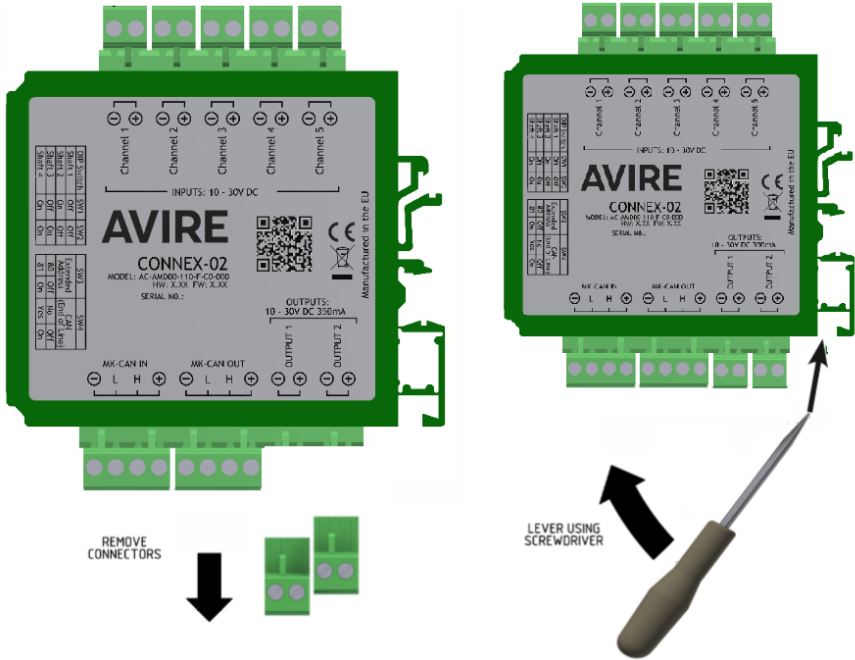

ENVIRONMENT CONDITIONS

This device is designed to be used indoors (0°C to 45°C with relative humidity between 20% to 80% not condensing). Sudden changes of temperature and humidity should be avoided.

CLEANING AND MAINTENANCE

Use a soft dry cloth. Do not use solvent or abrasive products.

SAFETY

Please read these safety instructions before starting the device.

- + Do not expose this device to liquids or excessive humidity. The Connex-02 is an indoor device and is not waterproof.
- + Do not expose the device to fire.
- + Do not try to modify the device.
- + Do not use the device in potentially hazardous areas or where there is risk of explosion.

The Connex-02 emits low levels of radio frequency when in operation.

DISPOSAL

The device complies with regulations 2002/95/CE and 2003/108/CE regarding the use and disposal of hazardous substances in electric appliances.

Do not dispose of this device with unsorted household waste. Disposing of the device in an unauthorised way could result in a fine in line with local regulations.



ENVIRONMENTAL REGULATIONS

RoHS - Avire certifies that its production process complies with the 2002/95/CE European Directive of 27 January 2003 regarding the restriction of use of hazardous substances in electric and electronic appliances.

